



FEATURES

- Single fiber bi-directional data links TX 9.95Gbps, Burst Mode RX 9.95G/2.488Gbps application
- 0 to 70°C operating case temperature
- 3.3V power supply
- XFP package with SC Receptacle connector
- Hot-pluggable capability
- High power 1577nm EML LD & High sensitivity 1270nm APD
- Support 20km transmission distance with SMF
- SD indication
- Low EMI and excellent ESD protection
- Digital diagnostic monitor interface
- RoHS6 compliance

APPLICATIONS

- XGS-PON XFP OLT N1

STANDARDS

- Complies with INF-8077i
- Complies with ITU G.987.2
- Complies with FCC 47 CFR Part 15, Class B
- Complies with FDA 21 CFR 1040.10 and 1040.11

ABSOLUTE MAXIMUM RATING

Parameter	Symbol	Min.	Max.	Unit	Notes
Storage Ambient Temperature	T_{STG}	-40	85	°C	
Operating Case Temperature	T_c	0	70	°C	
Operating Humidity	OH	5	85	%	
VCC3 Power Supply Voltage	VCC3	-0.5	3.6	V	

RECOMMENDED OPERATING CONDITION

Parameter	Symbol	Min.	Typ.	Max.	Unit	Notes
Operating Case Temperature	T_c	0		+70	°C	
VCC3 Power Supply Voltage	VCC3	3.13	3.3	3.47	V	
VCC3 Power Supply Current	ICC3		-	1000	mA	
Date Rate			9.95 2.488		Gbps Gbps	
Date Rate Drift		-100		+100	PPM	
Power Consumption	P		-	3	W	

TRANSMITTER OPTICAL CHARACTERISTICS

Parameter	Symb	Min.	Typ.	Max.	Unit	Notes
Optical Center Wavelength	λ_c	1575		1580	nm	
Optical Spectrum Width (-20dB)	$\Delta\lambda$	-	-	1	nm	
Side Mode Suppression Ratio	SMSR	30			dB	
Optical Waveform Diagram		Compliant with ITU G.987.2				Figure 1, Mask Margin>10%
Average Launch Optical Power (BOL)	AOP2	+2.5		+6	dBm	Launched into SMF
Average Launch Optical Power (EOL)		+2		+6	dBm	
Power-OFF Transmitter Optical Power				-39	dBm	Launched into SMF
Extinction Ratio	ER	8.2			dB	PRBS2 ³¹ -1 @9.95Gbps
Total Jitter	TJ			0.39	UI	PRBS2 ³¹ -1 @9.95Gbps
RIN ₁₅ OMA				-128	dB/Hz	
Transmitter Reflectance				-10	dB	
Transmitter and Dispersion Penalty	TDP			1	dB	Transmit on 20km SMF

TRANSMITTER ELECTRICAL CHARACTERISTICS

Parameter	Symbol	Min.	Typ.	Max.	Unit	Notes
Data Input Differential Swing		120		850	mV	CML input, AC coupled
Input Differential Impedance		90	100	110	Ω	

Transmitter Enable Voltage - Low		0		0.8	V	
Transmitter Disable Voltage - High		2.0		V _{CC}	V	

TRANSMITTER EYE MASK DEFINITIONS AND TEST PROCEDURE

Figure 1 XGSPON Transmitter Eye Mask Definitions

X3-X2	Y1	Y2	Y3	Y4	Unit
0.2	0.25	0.75	0.25	0.25	UI

10G PON RECEIVER OPTICAL CHARACTERISTICS

Parameter	Symbol	Min.	Typ.	Max.	Unit	Notes
Operating Wavelength		1260		1280	nm	
Max Optical input				0	dBm	input without incurring damage
Sensitivity (BOL)				-29	dBm	PRBS2 ³¹ -1@9.95Gbps BER ≤1×10 ⁻³
Sensitivity (EOL)	SEN			-28	dBm	PRBS2 ³¹ -1@9.95Gbps BER ≤1×10 ⁻³
Saturation Optical Power	SAT	-6			dBm	PRBS2 ³¹ -1@9.95Gbps BER ≤1×10 ⁻³
SD Assert Level				-30.5	dBm	
SD De-assert Level		-45			dBm	
Hysteresis		0.5		6	dB	
Receiver Reflectance				-12	dB	

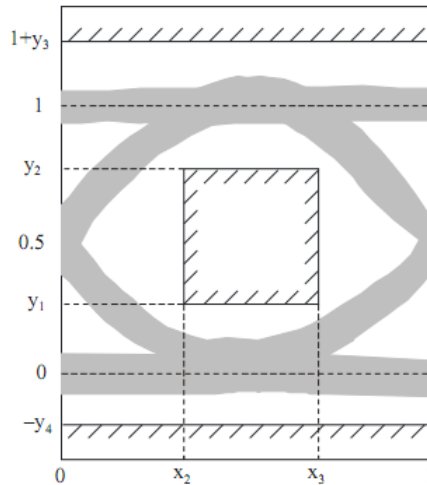
2.5G PON RECEIVER OPTICAL CHARACTERISTICS

Parameter	Symbol	Min.	Typ.	Max.	Unit	Notes
-----------	--------	------	------	------	------	-------

Operating Wavelength		1260		1280	nm	
Max Optical input				0	dBm	input without incurring damage
Sensitivity (BOL)				-28.5	dBm	PRBS 2 ²³ -1@2.488Gbps BER ≤1×10 ⁻⁴
Sensitivity (EOL)	SEN			-27.5	dBm	PRBS 2 ²³ -1@2.488Gbps BER ≤1×10 ⁻⁴
Saturation Optical Power	SAT	-7			dBm	PRBS 2 ²³ -1@2.488Gbps BER ≤1×10 ⁻⁴
SD Assert Level				-30.5	dBm	
SD De-assert Level		-45			dBm	
Hysteresis		0.5		6	dB	
Receiver Reflectance				-20	dB	

TIMING PARAMETER DEFINITIONS IN BURST MODE SEQUENCE

Parameter	Symbol	Min.	Typ.	Max.	Unit.	Notes
RSSI Trigger-Low		0		0.8	V	
RSSI Trigger-High		2.0		V _{cc}	V	
Data Output Differential Swing		340		850	mV	CML output, DC coupled
Reset-Low		0		0.8	V	
Reset-High		2.0		V _{cc}	V	
SD Voltage-Low		0		0.4	V	
SD Voltage-High		2.4		V _{cc}	V	
Reset Width	A	TBD			ns	
Reset to Valid Data Delay	B	TBD			ns	
SD De-assert Time	C			TBD	ns	
SD Assert Time	D			TBD	ns	
Data recovery time				400	ns	PRBS 2 ²³ -1@2.488Gbps
				400	ns	PRBS 2 ³¹ -1@9.95Gbps

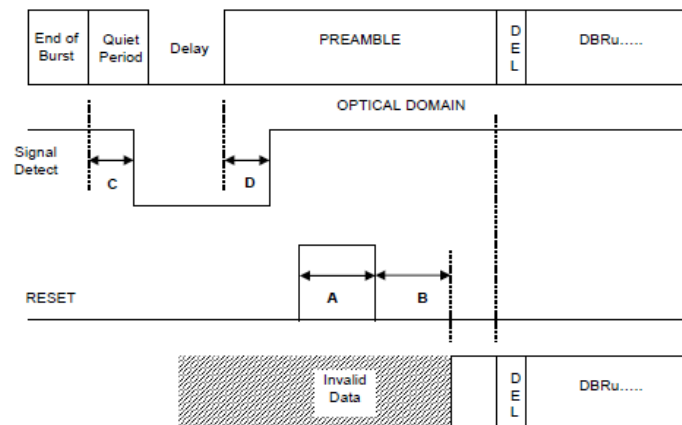
Figure 2 Reset Signal Timing Diagram in Normal Mode

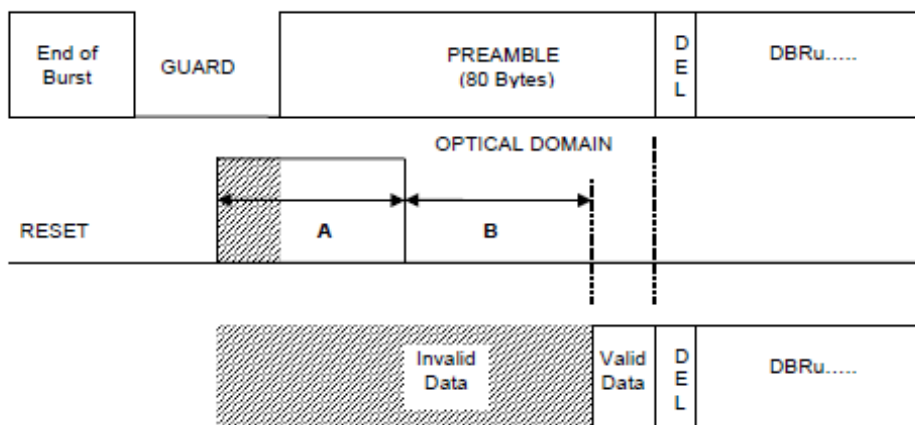

Figure 3 Reset Signal Timing Diagram in Ranging Mode

RSSI TIMING SEQUENCE						
Parameter	Symbol	Min.	Typ.	Max.	Unit.	Notes
Optical Signal During Time	T_{ont}	1200			ns	
RSSI Trigger width	T_w	500			ns	
RSSI Trigger Delay	T_D	150			ns	
I ² C Access Prohibited Time		500			μ s	

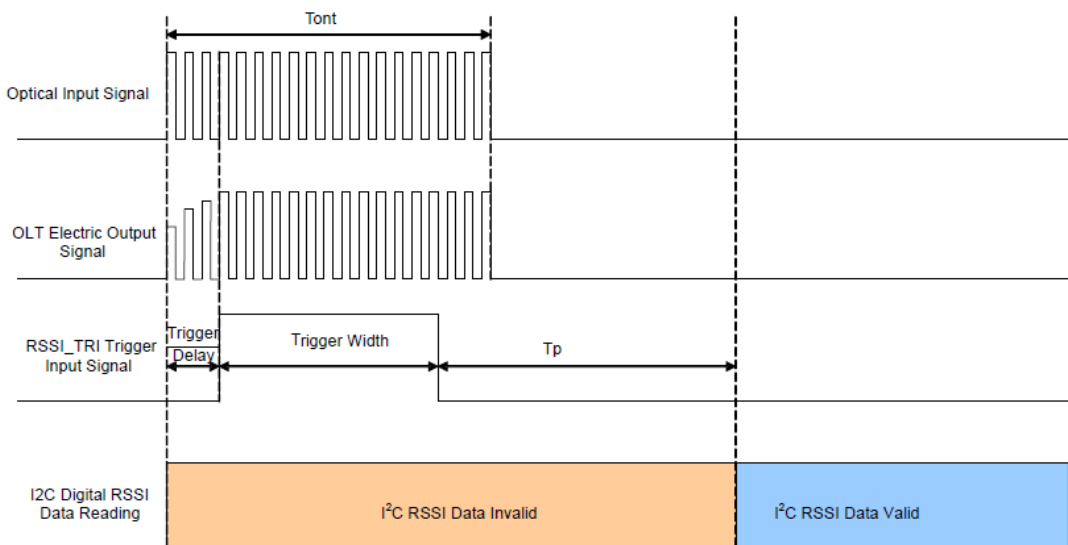
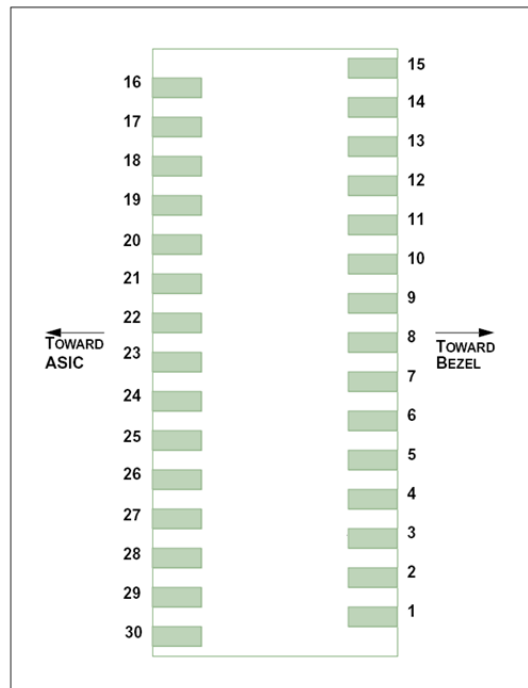
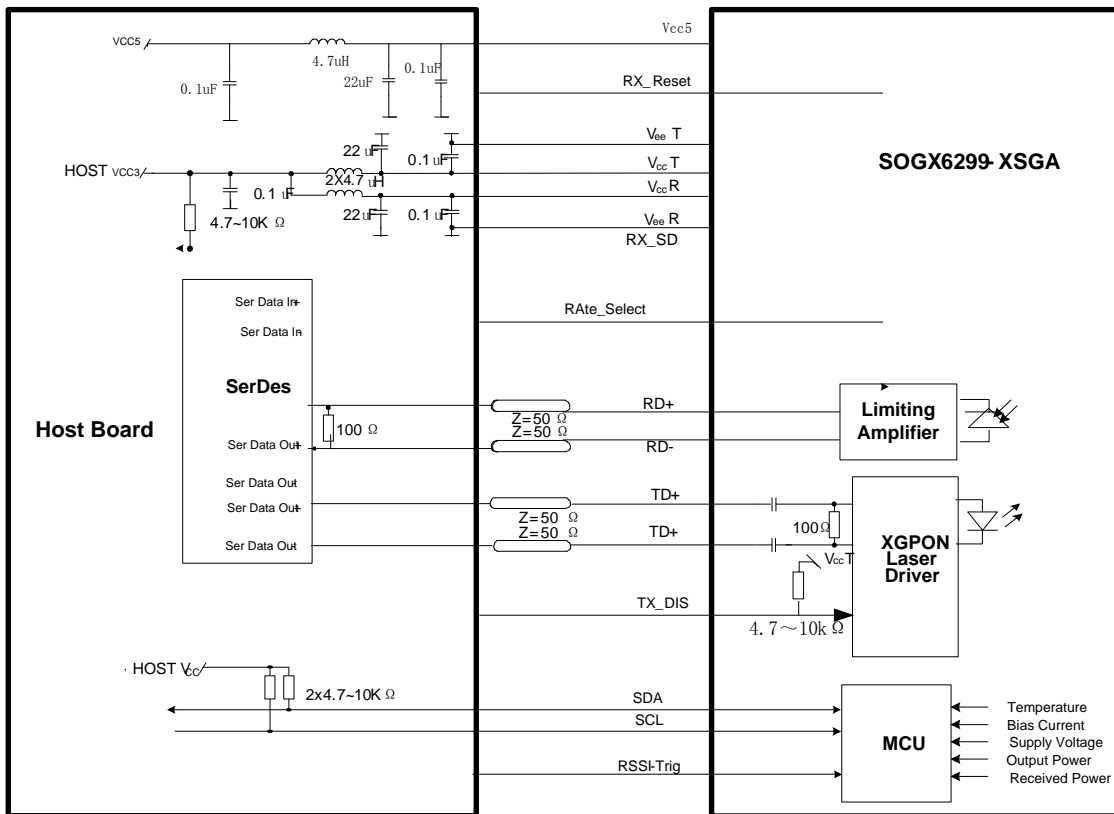

Figure 4 Timing Parameter Definitions in RSSI Trigger

PIN OUT DRAWING

Figure 5 Pin Out Drawing

PIN DESCRIPTION			
PIN	Name	Description	Notes
1	GND	Module Ground	
2	TX_FAULT	Transmitter Status Indication	Low: Normal; High: Abnormal
3	NC	Not be Connected in the transceiver	
4	NC	Not be Connected in the transceiver	
5	TX_DIS	Transmitter Disable	LVTTTL Input by 10k pull up resistor, Low: transmitter on
6	VCC5	+5V Power Supply	
7	GND	Module Ground	
8	VCC3_TX	Transmitter 3.3V Power Supply	
9	VCC3_RX	Receiver 3.3V Power Supply	
10	SCL	The clock line	The clock line of two wire serial interface
11	SDA	The data line	The data line of two wire serial interface
12	MOD_ABS	Indicates Module is not present.	Grounded in the Module
13	RX_Reset	Burst Receiver Reset	LVTTTL, High level Reset
14	SD	SD Indication	LVTTTL output, active LOW when the receiver lost signal
15	RateSel	Rate Indication	LVTTTL output, High:2.488G RX; LOW:9.95G RX

16	GND	Module Ground	
17	RD_N	Inverted Received Data Out	CML output, DC coupled; No squelch function
18	RD_P	Non-inverted Received Data Out	CML output, DC coupled; No squelch function
19	GND	Module Ground	
20	NC	Not be Connected in the transceiver	
21	RSSI_TRIG	RSSI Trigger for Transceiver	High value indicates start RSSI measurement
22	NC	Not be Connected in the transceiver	
23	GND	Module Ground	
24	NC	Not be Connected in the transceiver	
25	NC	Not be Connected in the transceiver	
26	GND	Module Ground	
27	GND	Module Ground	
28	TX_N	Inverted Transmit Data in	CML input, AC coupled
29	TX_P	Non-Inverted Transmit Data in	CML input, AC coupled
30	GND	Module Ground	

TYPICAL INTERFACE CIRCUIT

Figure 6 Typical Interface Circuit
PACKAGE OUTLINE

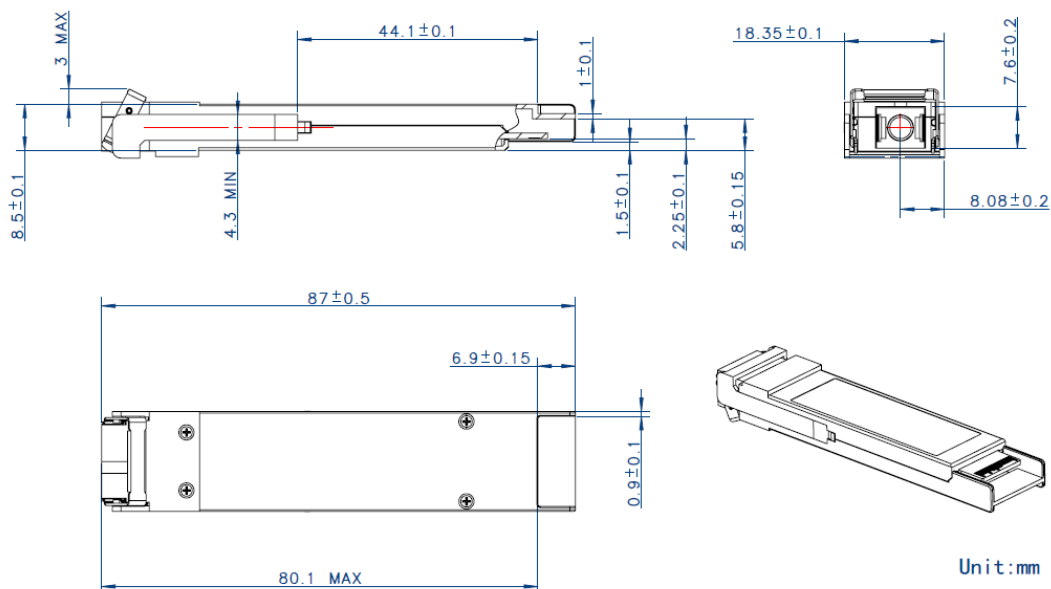

Figure 7 Package Outline

EEPROM INFORMATION

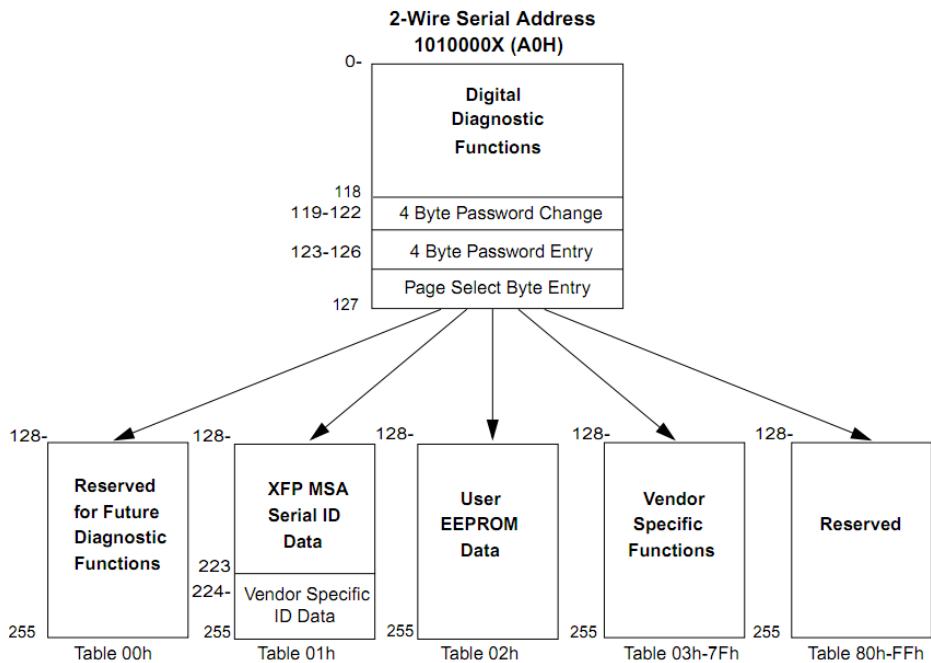

Figure 8 EEPROM Memory Map Specific Data Field Descriptions

DIGITAL DIAGNOSTIC MONITORING INTERFACE

Parameter	Range	Accuracy	Calibration	NOTES
Temperature	0 to 70°C	±3°C	Internal	LSB: 1/256°C
Voltage	0 to 3.6V	±5%	Internal	LSB: 0.1mV
Bias Current	0 to 262mA	±10%	Internal	LSB: 4uA
TX Power	0 to 8dBm	±2dB	Internal	LSB: 0.2uW
RX Power	-29 to -6dBm	±3dB	Internal	LSB: 0.1uW

ORDERING INFORMATION

PN	Temperature Rating	Unit
SOGX6299-XSGA	0 ~ 70	°C

WARNINGS

- Handling Precautions: This device is susceptible to damage as a result of electrostatic discharge (ESD). A static free environment is highly recommended. Follow guidelines according to proper ESD procedures.
- Laser Safety: Radiation emitted by laser devices can be dangerous to human eyes. Avoid eye exposure to direct or indirect radiation.

LEGAL NOTES

- All information contained in this document is subject to change without notice, at Superxon's sole and absolute discretion. Superxon Technology warrants performance of its products to current specifications only in accordance with the company's standard one-year warranty; however, specifications designated as "preliminary" are given to describe components only, and Superxon Technology expressly disclaims any and all warranties for said products, including express, implied, and statutory warranties, warranties of merchantability, fitness for a particular purpose, and non-infringement of proprietary rights. Please refer to the company's Terms and Conditions of Sale for further warranty information.
- Superxon Technology assumes no liability for applications assistance, customer product design, software performance, or infringement of patents, services, or intellectual property described herein. No license, either express or implied, is granted under any patent right, copyright, or intellectual property right, and Superxon Technology makes no representations or warranties that the product(s) described herein are free from patent, copyright, or intellectual property rights. Products described in this document are NOT intended for use in implantation or other life support applications where malfunction may result in injury or death to persons. Superxon Technology customers using or selling products for use in such applications do so at their own risk and agree to fully defend and indemnify Superxon Technology for any damages resulting from such use or sale.
- THE INFORMATION CONTAINED IN THIS DOCUMENT IS PROVIDED ON AN "AS IS" BASIS. Customer agrees that Superxon Technology is not liable for any actual, consequential, exemplary, or other damages arising directly or indirectly from any use of the information contained in this document. Customer must contact Superxon Technology to obtain the latest version of this publication to verify, before placing any order, that the information contained herein is current.
- Copyright © 2016 Sichuan Superxon Information Technology Co., Ltd.

All rights reserved.